

FOUR POST LIFT OPERATION MANUAL

4QJY3.5-B



CONSERVING THE MANUAL

The manual is an integral part of the lift, which it should always accompany even if the unit is sold. The manual, must be kept in the vicinity of the lift in the easily accessible place so that the operator and maintenance staff must be able to locate and consult the manual quickly at any time.



ATTENTIVE AND REPEATED READING OF SAFETY INSTRUCTION, WHICH CONTAINS IMPORTANT INFORMATION AND SAFETY WARNINGS, IS PARTICULARLY RECOMMENDED.

CONTENT

1	Safety.....	3
	1.1.1 Introduction.....	3
	1.1.2 Symbols.....	4
	1.1.3 Intended Use.....	4
	1.1.4 Safety Instructions for commissioning.....	5
	1.1.5 Safety Instructions for Servicing.....	7
2	Purpose and characteristics.....	8
3	Main technique parameters.....	9
	3.1.1 STORAGE.....	9
	3.1.2 OPENING THE CRATES.....	9
	3.1.3 DISPOSAL OF CRATES.....	9
4	TRABSPORTATION.....	9
5	UNPACKING.....	10
6	INSTALLATION AND TESTING.....	11
7	Maintenance.....	12
	7.1 Maintenance Schedule.....	12
8	Operation.....	13
	8.1 Defects/Malfunctions.....	13
	8.2 Controls.....	14
	8.2.1 Control unit	14
	8.3 Operation.....	16
	8.3.1 Preparations.....	16
	8.3.2 Raising.....	17
	8.3.3 Vehicle in Raised Position.....	18
	8.3.4 Lowering.....	19
	8.4 Protection against Unauthorized Usage.....	19
9	Troubleshooting.....	20
10	Electrical Systems.....	21
11	Hydraulic System.....	22

Safety

Introduction

Thoroughly read this manual before operating the lift and comply with the instructions. Always display the manual in a conspicuous location.

Personal injury and property damage incurred due to non-compliance with these safety instruction are not covered by the product liability regulation.

Symbols



Failure to comply with instructions could result in personal injury.



Failure to comply with instructions could result in property damage.



Important information

Intended Use

The lift is designed for the safe lifting of automotive vehicles. Observe the rated load capacity and load distribution of the lift.

	Load Capacity	Load distribution front: Rear	
		Minimum	Maximum
4QJY3.5-B	3500	1:2	2:1

In principle, the lift is designed for one approach directions.

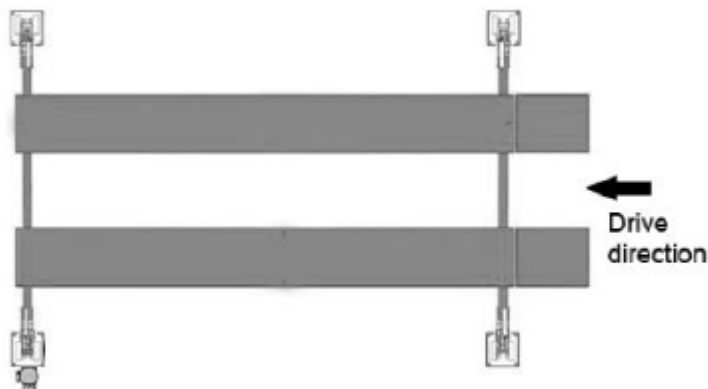

Safety Instructions for Commissioning

The lift may be installed and commissioned by authorized service personnel only.

The standard lift version may not be installed and commissioned in the vicinity of explosives or flammable liquids, outdoors or in moist rooms(e.g car wash)

Safety Instruction for Operation

Read the operating manual.

Lift operation by the authorized personnel over 18 years only.

Always keep the lift and lift area clean and free of tools. Parts, debris etc.

Once the template contact the lift points, check template for engagement.

After raising the vehicle briefly, stop and check the template for secure contact.

Always lift the vehicle doors are closed during raising and lowering cycles.

Closely watch the vehicle and the lift during raising and lowering cycles.

Do not allow anyone to stay in lift area during raising and lowering cycles.

Do not allow anyone on lift or inside raised vehicle.

Only use the lift for its intended purpose.

Comply with the applicable accident prevention regulations.

Do not overload the lift. the rated load capacity is indicated on the lift nameplate.

Only use the vehicle manufacturer's recommended lift points.

After positioning the vehicle apply the parking brake.

Use caution when removing or installing heavy components (center – of – gravity displacement).

The main switch serves as emergency switch. In case of emergency turn to position 0.

Protect all parts of the electrical equipment from humidity and moisture.

Protect the lift against unauthorized usage by padlocking the main switch.

Safety Instruction for Servicing

Maintenance or repair work by authorized service personnel only.

Turn off and padlock the main switch before doing any maintenance, or repair work

Work on electrical parts by authorized service personnel only.

Work on the electrical equipment by certified electricians only.

Ensure that ecologically harmful substances are disposed of only in accordance with the appropriate regulations.

Safety Instructions for Servicing

- ⑩ Maintenance or repair work by authorized service personnel only.
- ⑩ Turn off and padlock the main switch before doing any maintenance, or repair work.
- ⑩ Work on electrical parts by authorized service personnel only.
- ⑩ Work on the electrical equipment by certified electricians only.
- ⑩ Ensure that ecologically harmful substances are disposed of only in accordance with the appropriate regulations.
- ⑩ Do not use high pressure / steam jet cleaners or caustic cleaning agents. Risk of damage!
- ⑩ Do not replace or override the safety devices.
- ⑩ The MSDS of the hydraulic oil shall be obtained and kept at the easily accessible place for reference in the emergency situation

Friendly attention

- 1. Please check lift before work. If the lift is not balanceable, please adjust the lift and check the safe catching.**
- 2. You must enhance the lift above the safe mechanical lock, and then begin your work.**
- 3. Please check the parts of transmission and slippage frequently. Please infuse the oiling on the shaft of wheel between the axles every 5 to 7 days.**
- 4. Work please refers to the instruction and safe guide picture.**
- 5. Please change the oil upon the season(summer 46#/winter 32#)**

1. Purpose and characteristics

4QJY3.5-B four post hydraulic car lift suits for the checking, maintenance of different kinds of automobile, and especially for working outside.

The lift uses the platforms to support the car.

For steady running; good quality Chinese pump and electronic units, mechanical racks self-lock and hydraulic pressure are adopted, safe and credible: No need the preparation of the basement, fix it to the ground is ok.

This machine is composed of hoisting frame and hydraulic system.

2.Main technique parameters

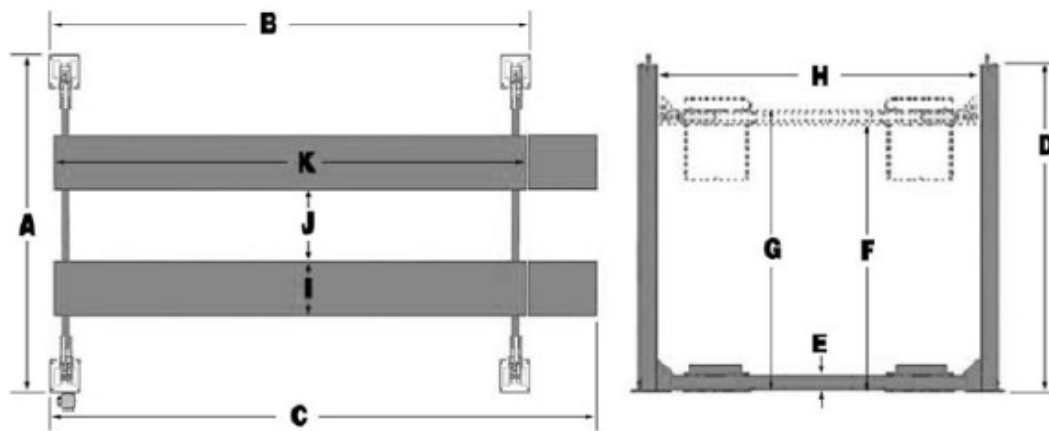

Model:	4QJY3.5-B
Lifting Capacity	3500kg
Lifting Height	1750mm
Mini height	160mm
Size(L*W*H)mm	4750*2970*2120
Lifting Time	40-70s
Motor Power	2.2kw
Power supply	3-400v/50hz
Power oil pressure	20Mpa
Net weight	1296kg
Noise level	<70dB

STORAGE

Packed machinery must always be kept in a covered, protected place, at a temperature between -10°C and $+40^{\circ}\text{C}$ and must not be exposed to direct sunlight.

OPENING THE CRATES

When the crates arrive, check that the machine has not been damaged during transport and that all parts listed are present. The crates must be opened using all possible precautionary measures to avoid damaging the machine or its parts. Make sure that parts do not fall from the crate during opening.

DISPOSAL OF CRATES

The wood of the crates may be reused or recycled.

3. TRANSPORTATION

For transport easily, the PACKAGE are bolted together with BELT, and control unit is packed into a plywood case. It must be moved by suitable capacity forklift truck at the middle of package.



Moving and positioning operation can be very dangerous if not performed with the utmost caution. Check the integrity and suitability of the available means.



ALL PACKING, LIFTING, HANDLING, TRANSPORT AND UNPACKING OPERATIONS ARE TO BE PERFORMED EXCLUSIVELY BY EXPERT PERSONNEL WITH KNOWLEDGE OF THE LIFT AND THE CONTENTS OF THIS MANUAL

The PACKAGE may be lifted and moved with a lift truck (Fig.1). If either of the latter two is used, crates must be harnessed with at least 2 slings.

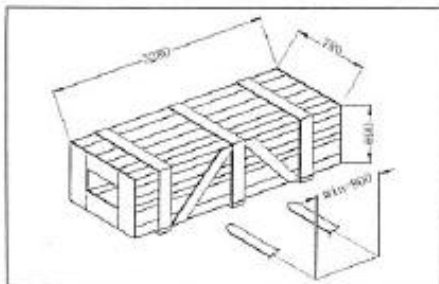

Fig.1

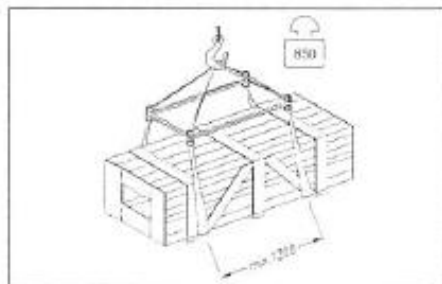
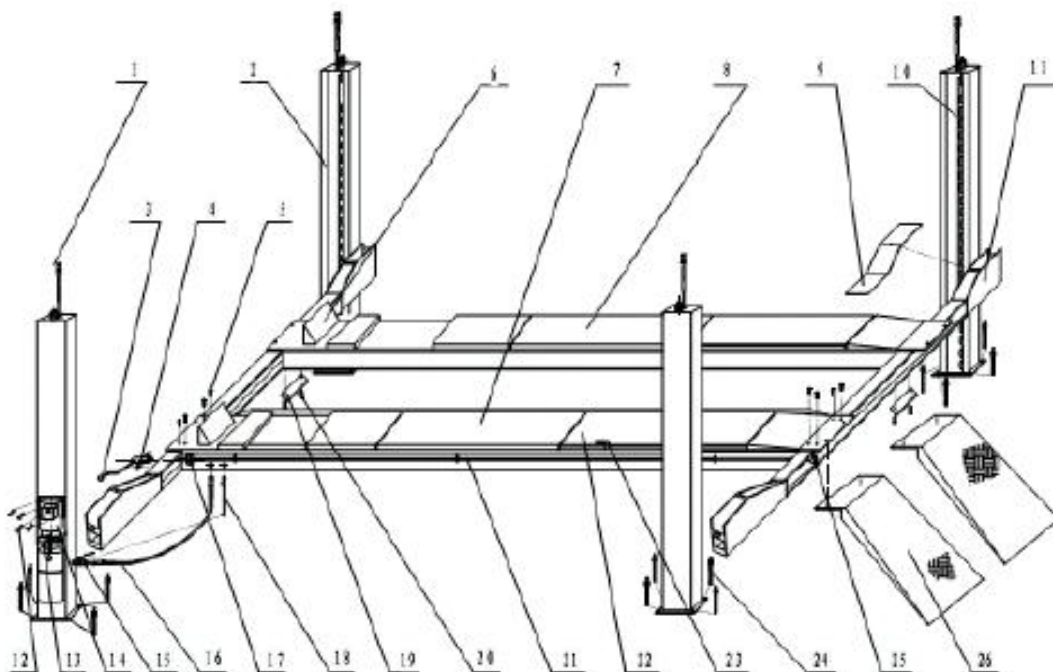

Fig.2

The equipment chosen must be suitable for safe lift in

4. UNPACKING

Check that the equipment is in perfect condition, making sure that no parts damaged or missed. Use below figure for reference. If in doubt, do not use the machine and contact your retailer.



Note: please reference to the numbers on this diagram to the relevant construction with the machine.

5. Installation and testing

1. Take out the machine from the packing and place it on the ground



Please pay attention to Lift Stability!

Please use the attached bolts to install the post onto the ground after machine assembled.

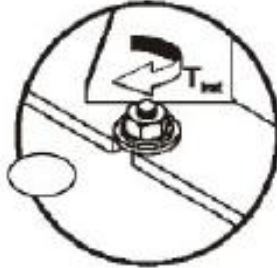

Note: Every six months check the nuts of all anchor bolts for correct installation torque $T_{inst.}$

	Installation Torque $T_{inst.}$
4QJY3.5-B	80 Nm

2. Then connect the oil tube.

3. Fill the hydraulic oil

Fill 10 liters of hydraulic oil into oil box (hydraulic oil provided by user)

4. connecting the electrical power

5. the power of this machine is 3~400v/50hz/2.2kw. please connect the power the terminal marked with "L1,L2,L3,PE" in the electrical cabinet

6. Adjust the machine

Turn on power supply, press "ascend" button UP to 100~200mm, then press "descend" handle. Redo it for 4-5 times, and add the height 100-200 each time. that can be use if it runs normally.

4. WORKING CONDITIONS:

1. Regarding ambient temperature shall be 5-40 degrees Celsius.

2. Regarding humidity shall be 30-95%.

3. Regarding transportation and storage temperature shall be between 25-55 degrees Celsius. And short period no exceeding 24 hours at up to 70 degrees Celsius.

4. Regarding installation altitude max 1000m.

6. Maintenance



Turn off and lock the main switch before servicing the lift.



The maintenance intervals indicated below apply to average workshop use.
The lift should be inspected more frequently for severe use applications.

6.1 Maintenance Schedule

Establish a periodic preventive maintenance procedure to ensure trouble free operation and long service life.

Interval	Maintenance to be performed on	Items
1 week	Support template	Add with oil poy on all branch hinge axes of this machine
6 months	Grassing points	Check and lubricate as require
	Nuts of anchor bolts	Check all nuts for correct torque and retighten them as required.
12 months	Hydraulic system	1.Check fluid level 2.Change hydraulic oil. Clean the oil box filter while changing oil. Keep oil level on the upper limit for long time. 3.Check tightness of hoses and fittings.

7. Operation

Lift operation by authorized personnel over 18 years only.
Apply the parking brake after positioning the vehicle on the lift.
Do not allow anyone to stay in lift area during raising and lowering cycles.
Closely watch the vehicle and the lift during raising and lowering cycles.



Observe the rated load capacity and load distribution.
Do not allow anyone to climb on lift or stay inside vehicle.
After raising the vehicle briefly, stop and check adapter for secure contact
Make sure the vehicle doors are closed during raising and lowering cycles.
Remove obstacle around before working.
Weight of lifted car should not be over the lifting capability.
Before lifting, please set well ascending or descending. Stop the machine if any abnormality, check and exclude failure.
When equipment is not under work or at night, descent it to the lowest position, and drive the car away, then turn off power supply.

7.1 Defects/Malfunctions



In case of defects or malfunctions such as jerky lift movement or deformation of the Superstructure, support or lower the lift immediately.
Turn off and padlock the main switch. Contact qualified service personnel.

7.2 Controls

7.2.1 Control Unit

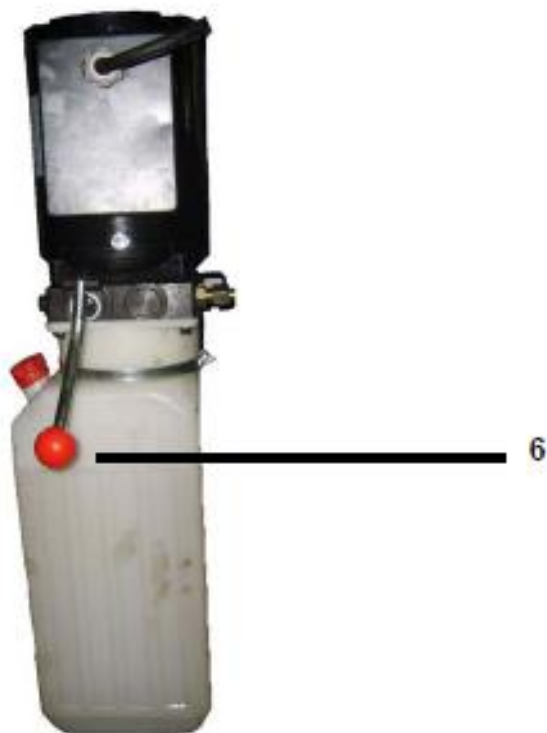
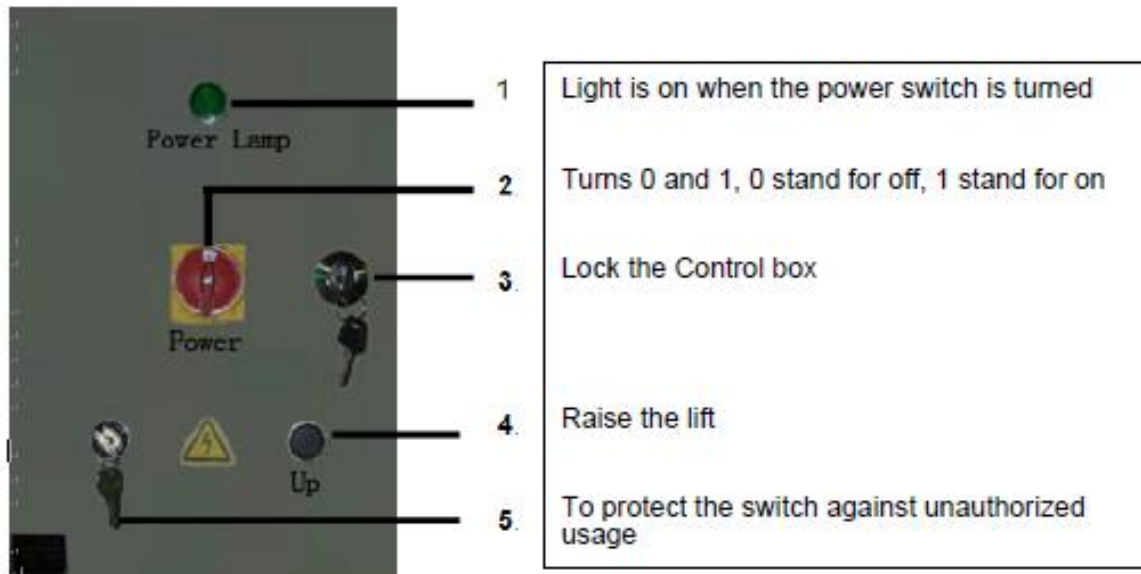

Unloading Handle: Lower the lift or set the lift on mechanical locks



The main switch is used as emergency stop switch. In case of emergency turn it to position 0.

Main switch in position 0: Power supply is interrupted

Main switch in position 1: Lift is ready for operation

Once any button is actuated, press the Up button, the lift moves until the button is released

When the Up button is released, press the Unloading Handle once to set the lift on the mechanical locks automatic.

Press the Up button once first, insure the safety plate is in disengaged position, press the Unloading Handle to lower the lift



Unloading Handle ←



7.3 Operation

7.3.1 Preparations

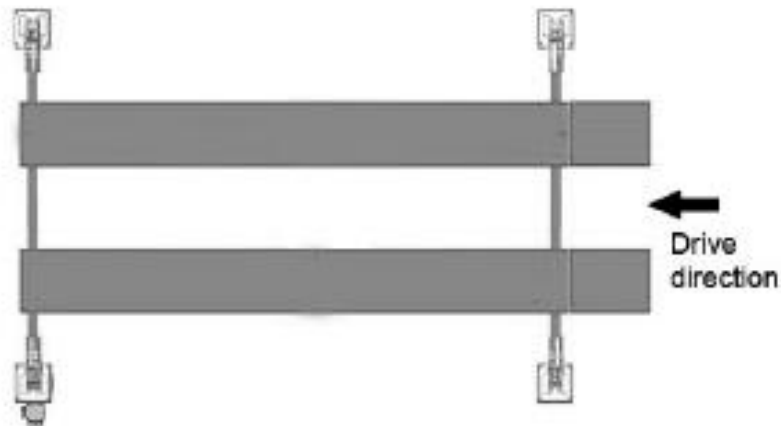

1 Fully lower the platform.

2 Slowly position vehicle midway between platforms. Apply the parking brake



3 leave vehicle and remain clear of lift



Always lift the vehicle using all four wheels.

7.3.2 Raising



During raising and lowering cycles: Closely watch the vehicle and the lift, do not allow anyone to stay in lift area and make sure the vehicle doors are closed.

Once the template contact the wheel, check for engagement. After raising the vehicle briefly, stop and check for secure contact.

1 Turn the main switch to position 1.



Lift is ready for operation.

Press the “UP” button until lift reached desired height

7.3.3 Vehicle in raised position

1. Observe all accident prevention regulations.
2. Do not allow unauthorized persons to stay under the raised vehicle.
3. Avoid rocking of vehicle.
4. keep lift free of tools, parts, etc.
5. Fasten the vehicle to the support template using lashing straps when removing or installing heavy components.

Set on mechanical Locks

Use this Down Button to set the lift on the mechanical locks.

In this way the lift can be security fixed when the vehicle is in a raised position.



Mechanical lock releasing

7.3.4 Lowering



During raising and lowering cycles: Closely watch the vehicle and the lift, do not allow anyone to stay in lift area and make sure the vehicle doors are closed.

- 1 Remove tools, stands or other objects from lift bay.
 - 2 Turn the main switch to position 1.
- ☞ Lift is ready for operation.



Push "DOWN" button with the mechanical lock releasing handle pressed until lift reaches desired height.



Mechanical lock releasing handle

- 4 To lower the arms completely, release the "DOWN" button.

7.4 Protection against Unauthorized Usage

When in position 0, the main switch can be protected against tampering by means of a padlock.

8 Troubleshooting

Failure	Cause	Solution
Engine doesn't rotate	①Bad contact of wires	Check or change contact device
	② contact device doesn't work	Adjust or change limited switch
	③ bad action of limited switch	Check the electromagnetism valve and clean it
Engine rotates but not ascend	①have dust in the center of the electromagnetism valve	Check the electromagnetism valve and clean it
	②the line pole is loose	Fix it
	③falling short of hydraulic oil	Makeup hydraulic oil
The ascend speed is slow	The oil seal hole is leak	Change the oil seal
Shake in the running	Air in the hydraulic pressure loop	Release the air by redo the ascend and decent
	Air leak at the top connect oil tube mouth of the pump	Check the seal of the oil tube mouth
	Filtrate net is jam	Clean it
Only ascend, can not descend	①electromagnetic	Check it and mend it
	②connect invalidation in the button	Check the button
	③ electromagnetic valve blocked	Check or change electromagnetic valve
	④ descending electromagnetic valve unopened	Check or change electromagnetic valve
	⑤Hydraulic oil too dense(in winter)	Add oil according to the manual
Oil leak	Loose Tie-in	Screw the tie-in
	Mangled oil seal on tie-in	Change oil seal

9. Electrical Systems

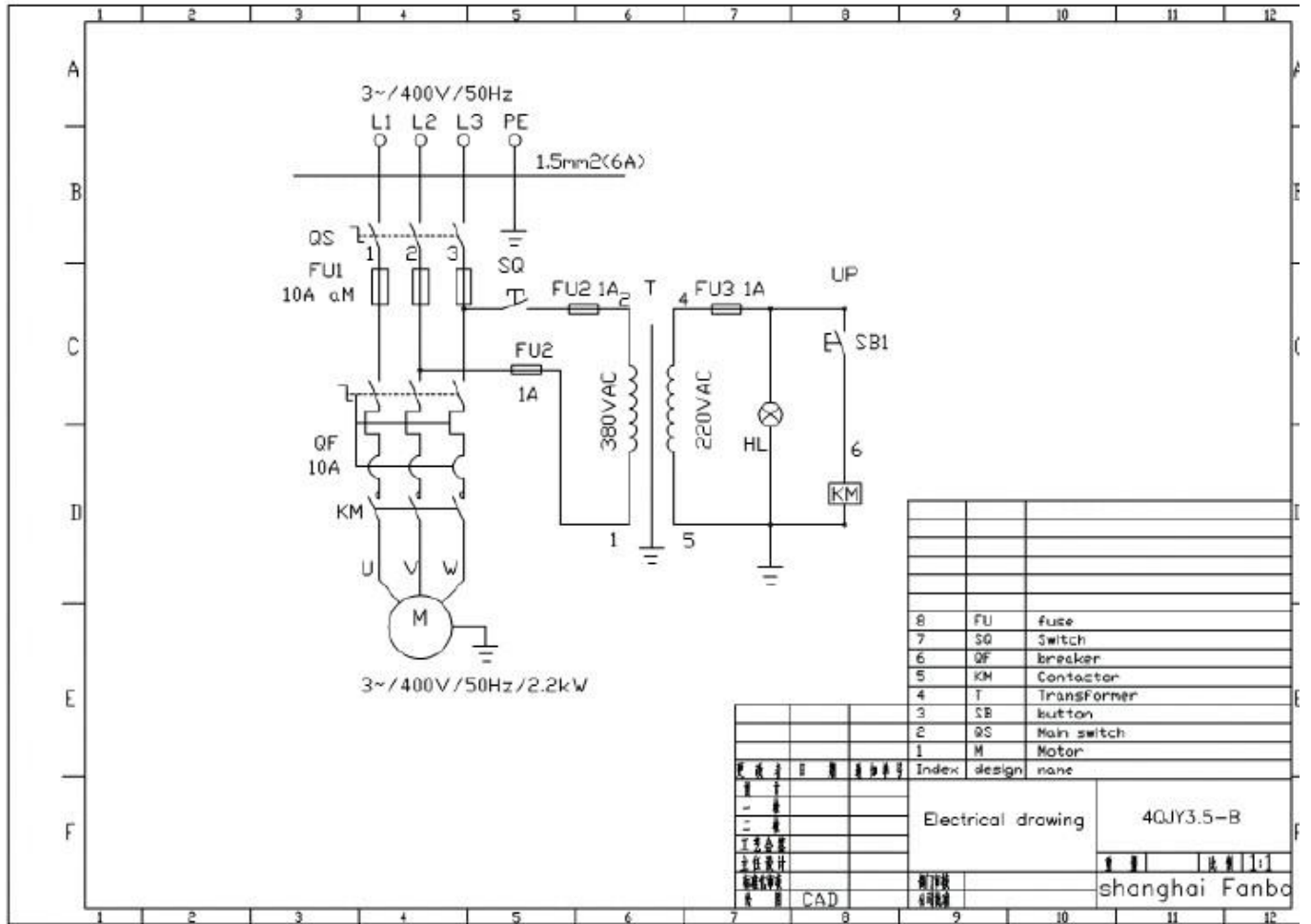

10. Hydraulic System

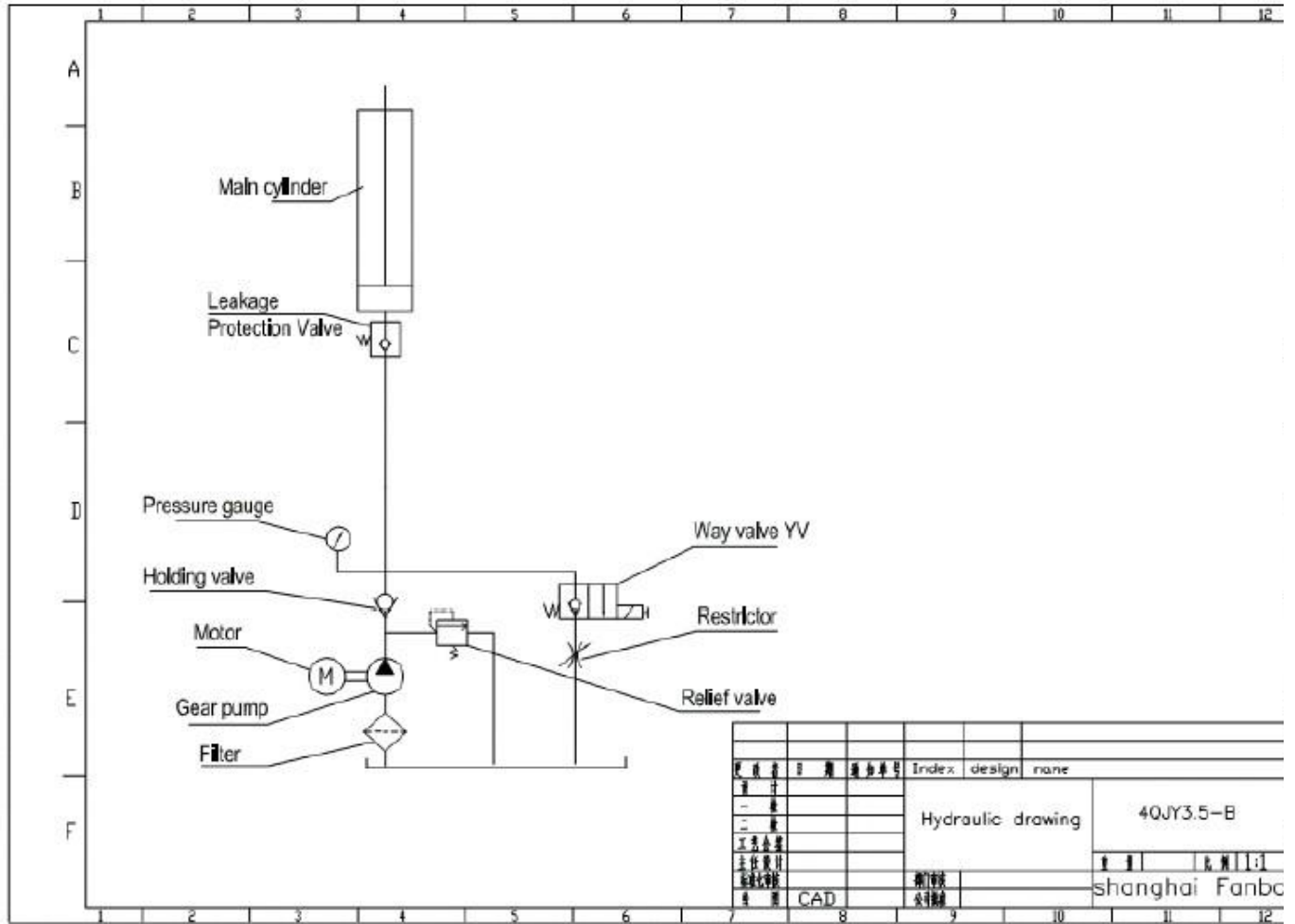

EC DECLARATION COMFORMITY

The equipment which accompanies this declaration is in conformity with EU Directive(s):

*98/37/EC Machinery Directive
2006/95/EC Low Voltage Directive
2004/108/EC Electromagnetic Compatibility Directive.*

Manufacturer Name/Address:

A copy of the Technical file for this equipment is available from:

CCQS UK Ltd

*A sample of this machinery has been presented to Notified Body number 1105,
CCQS UK Ltd., Suite B Regal Court, 112 London Road, Headington, Oxford OX3 9AW UK
Who have issued an EC type-examination certificate, Number CE-C-0225-08-11-13-5A, dated 2009.01
The equipment in respect of which this declaration is made conforms to the example to which that certificate relates,
and that certificate remains valid.*

Description of Equipment:

Product: *Four post vehicle lift*
Type designation/trademark: *AQJY3.5-B*
Series number: *090108*

The following harmonised standards have been used:

*EN60204-1:2006 Electrical Equipment of Industrial machines
EN1493:1998 vehicle lift*

Authorised signatory of manufacturer/authorised EU representative:

Signature: 
Name of signatory: *Fan minghua*
Position in company: *General Manager*
Place and Date: *shanghai/China/2009.01.10*